

BORZALINO
INTERIORS • 1976 • TUSCANY



FRANKLIN

FRANKLIN

La collezione Franklin è costituita da un sistema di sedute componibili in linea, curve e ad angolo. Le linee morbide e avvolgenti e il disegno moderno la rendono piacevolmente adatta ad un arredamento dal gusto internazionale e contemporaneamente orientato ad apprezzare le caratteristiche del buon design italiano.

Struttura: in multistrati di pioppo e legno massello. **Sospensione seduta:** cinghie elastiche incrociate. Imbottiture: scocca fissa in poliuretano espanso a quote differenziate di densità 30/35/40Kg/m³ e rivestito con trapuntino in piuma canalizzata per garantire una localizzazione della piuma netta e costante nel tempo. Il trapuntino in piuma conferisce morbidezza e soffici ta. Sedute estraibili in poliuretano espanso di densit  35Kg/m³ rivestito con trapuntino in piuma canalizzata che conferisce soffici ta al cuscino. **Dettaglio:** tutto il perimetro della scocca   delineato da una lavorazione ideata dallo studio stile BORZALINO denominata "TRAP"; mentre la seduta   arricchita da un bordino lineare in Gros-grain a contrasto. **Base:** in legno di rovere naturale o trattato in vari colori con appropriati sottopiedi in plastica. Si consiglia di arricchire la composizione con i cuscini arredo opzionali suggeriti nelle immagini. Tolleranza +/- 5cm delle dimensioni totali del prodotto.

EN

The Franklin collection consists in a system of modular in-line, curved and corner elements enhanced by a series of pouf. The soft and wrap-around lines and the modern design make it pleasantly suitable for a furnishing scheme of international taste, at the same time inclined to appreciate the features of good Italian design.

Structure: poplar plywood and solid wood. **Seat springing:** criss-crossed elastic straps. Fillings: fixed frame in differentiated density 30/35/40Kg/m³ polyurethane foam and covered with feather quilt channelled in order to guarantee that the feathers remain neatly and constantly in place over time. The feather quilt gives roundness and softness. Removable seat of density 35Kg/m³ polyurethane foam covered with feather quilt channelled that gives softness to the cushion. **Detail:** all the frame edge is outlined by a special workmanship, called "TRAP" designed by BORZALINO style studio. The seats are embellished with an elegant piping realized in Gros-grain with contrasting color. **Base:** solid wood oak natural or treated in several colors with appropriate plastic glides. It is advisable to embellish the sofa with the optional decorative pillows recommended in the images. Tolerance +/- 5cm of total product dimensions.

FR

La collection Franklin pr sente un concept de canap s et canap  d'angle enrichis d'une s rie de poufs. Les formes douces et enveloppantes et le design moderne le rendent agr ablement adapt    un ameublement au go t international et en m me temps orient    appr cier les caract ristiques du bon design italien.

Structure : carcasse en multiplis de peuplier et en bois massif. Suspension d'assise : sangles  lastiques entrecrois es. **Rembourrage :** carcasse fixe en mousse polyur thane densit  30/35/40 Kg/m³ couverts par un couette en duvet   secteurs pour garantir au duvet une localisation nette et constante dans le temps. La couette en duvet donne douceur et souplesse. Coussins d'assise amovibles en mousse polyur thane densit  35 Kg/m³ couvert par un couette en duvet   secteurs qu'il conf re rotondit  et souplesse. **D tail :** le pourtour ext rieur du canap  est enrichi d'un bordure con ue par le Studio de recherche et d veloppement BORZALINO appel  "TRAP", tandis que l'assise est garnie d'un passepoil en Gros-grain couleur contrast . **Base :** en bois de ch ne massif naturel ou trait  en couleurs diff rentes avec des patins en plastique appropri s. Il est conseill  d'orne  le canap  avec les coussins d coratifs optionnels propos s dans les images. Tol rance +/- 5 cm des dimensions totales du produit.

BORZALINO

INTERIORS • 1976 • TUSCANY



sofa 290x115 h 65/85 / Fabric art. SORBARA col. 160.
Frame detail "TRAP 01", seat cushions detail trimming Gros-grain col. 4527. Lacquered brown Oak wooden base.
back cushions / No. 2 fabric art. SORBARA col. 160, trimming Gros-grain col. 4527.
No. 1 fabric art. COMISO col. 5, trimming Gros-grain col. 4527.
No. 1 leather art. NABUK col. 83, trimming Gros-grain col. 4527.



sofa 390x175 h 65/85 / Curved Element 215 LHF + Curved Element 215 RHF
Fabric art. SIERRA L1634 col. 13. Frame detail "TRAP 09", seat cushions detail trimming Gros-grain col. 4503. Lacquered Brown Oak wooden base.
back cushions / No. 5 fabric art. Sierra L1634 col. 13, trimming Gros-grain col. 4503.
pillow 45x45 / No. 4 fabric art. Sierra L1634 col. 04, trimming Gros-grain col. 4503.

DETAILS



bordino Gros-grain
trimming Gros-grain
passepoil Gros-grain



TRAP
dettaglio di lavorazione
manufacture detail
détail de fabrication



base in legno
wooden base
base en bois

FRANKLIN



love seat 175x115 h 65/85 / Fabric art. PALAZZO CA1175 col. 051. Frame detail "TRAP 03", seat cushion detail trimming Gros-grain col. 4503. Lacquered brown Oak wooden base.
back cushion / Fabric art. PALAZZO CA1175 col. 051, trimming Gros-grain col. 4503.

175 h 65/85 - prof/depth/prof **115**

EUFNLOSE /divanetto
 /love seat
 /causeuse

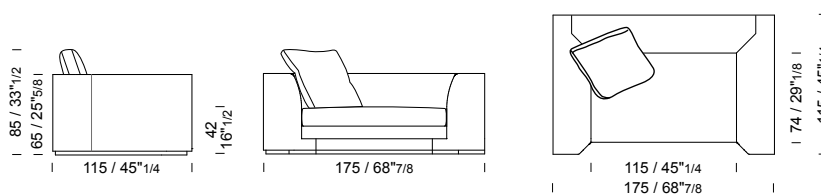

ALL 8 mt 11 m² 1,35 m³ 75 kg



sofa 230x115 h 65/85 / Leather art. RUSTICO col. 17. Frame detail "TRAP" 07.
 Seat cushions detail trimming Gros-grain col. 4527. Lacquered brown Oak wooden base.
back cushion / No. 2 leather art. RUSTICO col. 17, trimming Gros-grain col. 4527.
 No. 1 fabric art. COMISO col. 3, trimming Gros-grain col. 4527

115 h 65/85 - prof/depth/prof **115**

EUFNLS15 /laterale SX
 /element LHF
 /batard GVF

EUFNLD15 /laterale DX
 /element RHF
 /batard DVF

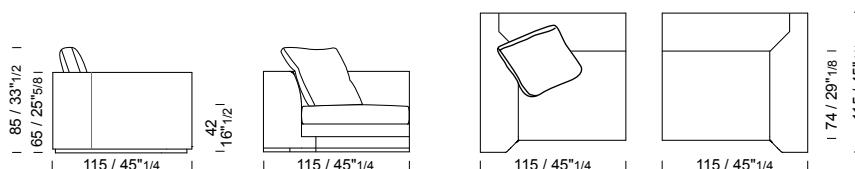

ALL 5,5 mt 7 m² 0,89 m³ 60 kg

FRANKLIN

125 h 65/85 - prof/depth/prof 115

EUFNLS25 /laterale SX
/element LHF
/batard GVF

EUFNLD25 /laterale DX
/element RHF
/batard DVF

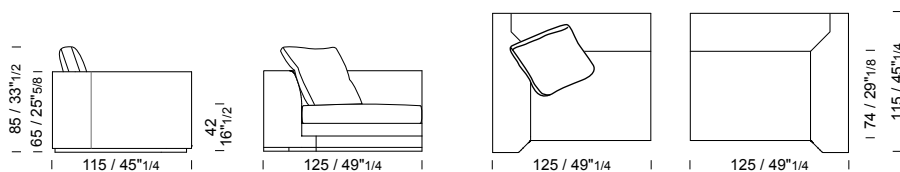

ALL 5,5 mt 7,5 m² 0,96 m³ 58 kg

135 h 65/85 - prof/depth/prof 115

EUFNLS35 /laterale SX
/element LHF
/batard GVF

EUFNLD35 /laterale DX
/element RHF
/batard DVF

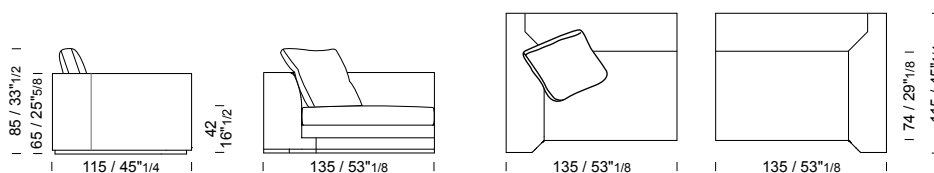

ALL 5,5 mt 8 m² 1,04 m³ 60,5 kg

145 h 65/85 - prof/depth/prof 115

EUFNLS45 /laterale SX
/element LHF
/batard GVF

EUFNLD45 /laterale DX
/element RHF
/batard DVF

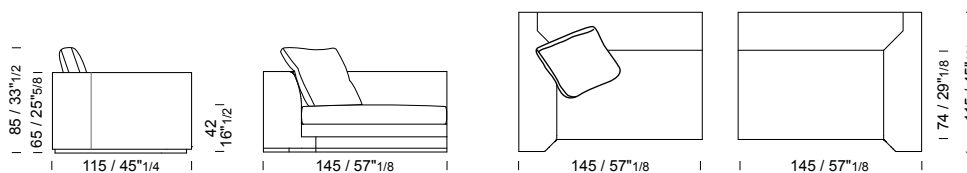

ALL 5,5 mt 8,5 m² 1,12 m³ 65 kg

115 h 85 - prof/depth/prof 165

EUFNPENS /penisola SX
/chaise longue LHF
/meridienne GVF

EUFNPEND /penisola DX
/chaise longue RHF
/meridienne DVF

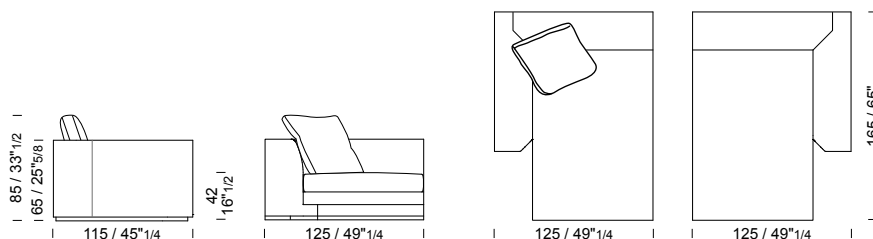

ALL 18 mt 14 m² 1,65 m³ 70 kg

FRANKLIN



sofa corner 405/250x115 h 65/85 /Element 125 LHF + Seat 95 + Corner 60° + Element 135 RHF
 Fabric art. SORBARA col. 4. Frame detail "TRAP 02", seat cushions detail trimming Gros-grain col. 4513. Lacquered black Oak wooden base.
back cushion / No. 3 fabric art. SORBARA col. 4, trimming Gros-grain col. 4513.
 No. 1 fabric art. COMISO col. 8, trimming Gros-grain col. 4513. No. 1 fabric art. COMISO col. 7, trimming Gros-grain col. 4513.
 No. 1 leather art. LIKE col. 13,trimming Gros-grain col. 4513.

85 h 65 - prof/depth/prof 105

EUFNS85 /centrale
 /seat
 /chauffeuse

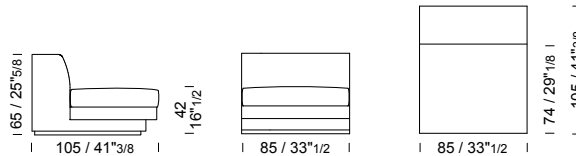

ALL 4,3 mt 4,5 m² 0,66 m³ 40 kg

95 h 65 - prof/depth/prof 105

EUFNS95 /centrale
 /seat
 /chauffeuse

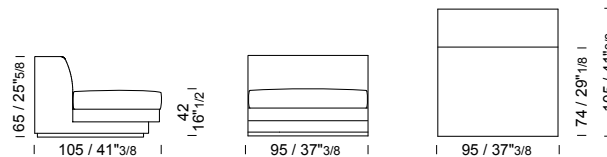

ALL 4,3 mt 5 m² 0,77 m³ 42,5 kg

105 h 65 - prof/depth/prof 105

EUFNS105 /centrale
 /seat
 /chauffeuse

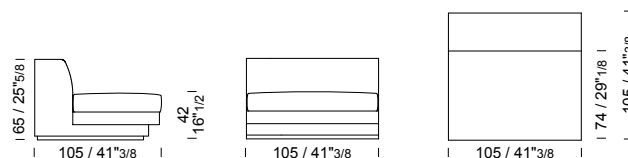

ALL 4,3 mt 5,5 m² 0,77 m³ 44 kg

FRANKLIN



sofa corner 345/260x115 h 65/85 /Element 125 LHF + Seat 95 + Corner 90° + Element 135 RHF
 Fabric art. ASOLO L1569 col. 03 and col. 04. Frame detail "TRAP. 01" - Trimming Gros-grain col. 4527. Lacquered Brown Oak wooden base.
back cushion / No. 1 leather art. GHOST col. 35. No. 2 fabric art. ASOLO L1569 col. 04. No. 3 fabric art. ASOLO L1569 col. 03.
 No. 1 fabric art. COMISO col. 3. No. 1 fabric art. COMISO col. 2.

115 h 65 - prof/depth/prof 105

EUFNS115 /centrale
 /seat
 /chauffeuse

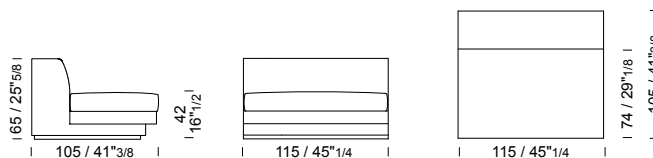

ALL 4,3 mt 6 m² 0,85 m³ 45 kg

110 h 65 - prof/depth/prof 110

EUFNANG6 /angolo 60°
 /corner 60°
 /angle 60°

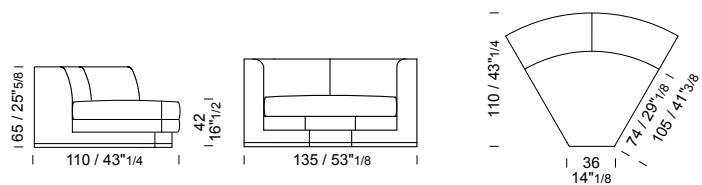

ALL 4 mt 5,5 m² 1,04 m³ 43,5 kg

125 h 65 - prof/depth/prof 125

EUFNANGO /angolo 90°
 /corner 90°
 /angle 90°

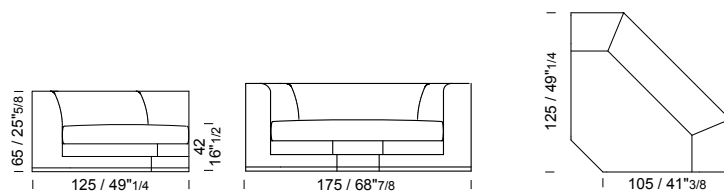

ALL 5,7 mt 7,5 m² 1,39 m³ 60 kg

FRANKLIN



sofa corner 490x275 h 65/85 /Curved Element 215 LHF + Curved Seat 188 + Curved Seat 188 + Curved Element 215 RHF
 Fabric art. SERRA L1634 col. 13. Frame detail "TRAP 09", seat cushions detail trimming Gros-grain col. 4503. Lacquered Brown Oak wooden base.
back cushion /No. 5 fabric art. SERRA L1634 col. 13, trimming Gros-grain col. 4503. No. 5 Velvet art. Labirinto col. 4, trimming Gros-grain col. 4503.
pillow 45x45 /No. 5 fabric art. SERRA L1634 col. 04, trimming Gros-grain col. 4503. No. 1 Velvet art. Labirinto col. 4, trimming Gros-grain col. 4503.

215 h 65 - prof/depth/prof 115

EUFNLC2S /laterale curvo SX
 /curved element LHF
 /batard GVF Galbé

EUFNLC2D /laterale curvo DX
 /curved element RHF
 /batard DVF Galbé

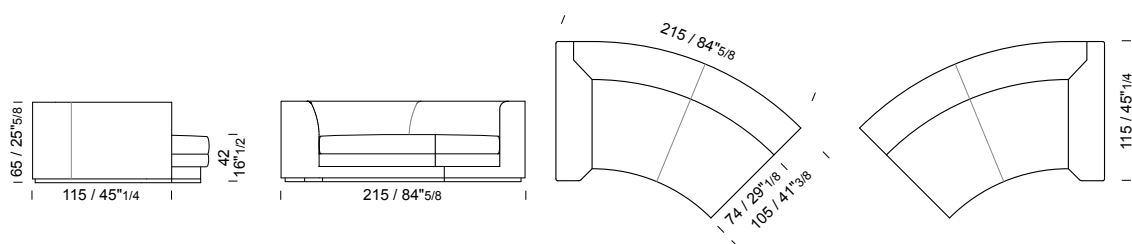

ALL 7 mt 10 m² 1,72 m³ 78 kg

188 h 65 - prof/depth/prof 105

EUFNSC18 /centrale curvo
 /curved seat
 /chauffeuse Galbé

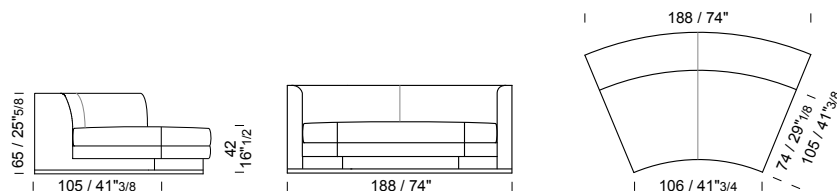

ALL 5,5 mt 7,5 m² 1,55 m³ 66 kg

105 h 65/85 - prof/depth/prof 165

EUFNTELS /terminale Lounge SX
 /Lounge element LHF
 /Lounge batard GVF

EUFNTELD /terminale Lounge DX
 /Lounge element RHF
 /Lounge batard DVF

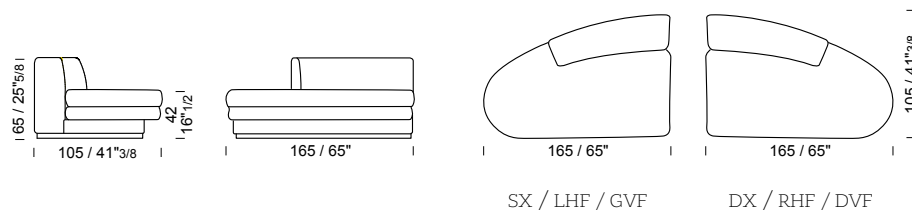

ALL 10 mt 7 m² 1,20 m³ 70 kg

FRANKLIN



sofa corner 455/220x115 h 65/85 /Lounge element 105 LHF + Curved seat 188 + Curved Element 215 arm RHF.
 Fabric art. LOOP K5042 col. 42. Frame detail "TRAP 07" seat cushions details trimming Gros-grain col. 4527- Lacquered brown Oak wooden base.
back cushion /No. 3 fabric art. KUBOA 9072 col. 04. No. 2 fabric art. BONSULTON Z625 col. 07.
 No. 2 leather art. SEQUOIA col. 4027. All with trimming Gros-grain col. 4527.

45x45x5

EUFNC45F /cuscino decorativo
 /pillow
 /coussin déco

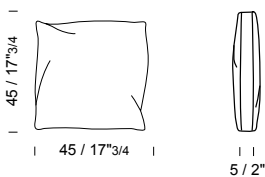



ALL  0,7 mt  1 m²

55x55x5

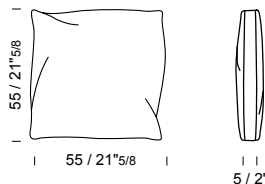
EUFNCSP /cuscino schienale
 /back cushion
 /coussin dossier



ALL  1 mt  1,5 m²

FRANKLIN



pouf 67x67 h 39
/Fabric art. COMISO col. 7.
Detail trimming Gros-grain col. 4513.



pouf 102x102 h 39
/Fabric art. SORBARA col. 4.
Sides fabric art. COMISO col. 7.
Detail trimming Gros-grain col. 4513.



pouf 122x122 h 39
/Fabric art. SORBARA col. 160.
Detail trimming Gros-grain col. 4527.



pouf 122x67 h 39
/Leather art. LIKE col. 13.
Detail trimming Gros-grain col. 4527.

67x67 h 39

EUFNP67 /pouf
/pouf
/pouf

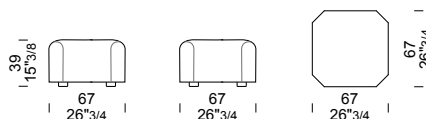

ALL 2,9 mt 3,8 m² 0,2 m³ 15 kg

122x67 h 39

EUFNP126 /pouf
/pouf
/pouf

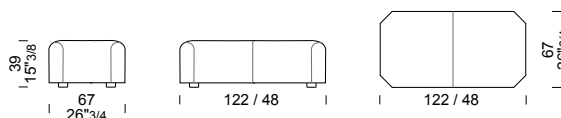

ALL 3 mt 4,5 m² 0,34 m³ 25 kg

92x92 h 39

EUFNP92 /pouf
/pouf
/pouf

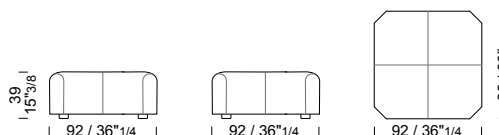

ALL 3 mt 4,5 m² 0,44 m³ 30 kg

102x102 h 39

EUFNP102 /pouf
/pouf
/pouf

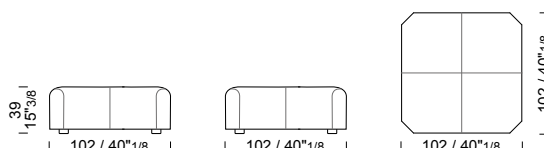

ALL 3,1 mt 4,9 m² 0,44 m³ 34 kg

112x112 h 39

EUFNP112 /pouf
/pouf
/pouf

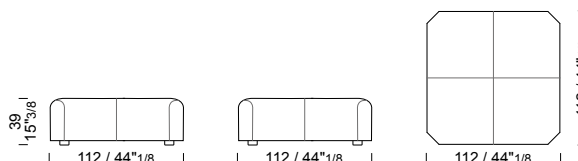

ALL 3,2 mt 5,3 m² 0,53 m³ 40 kg

122x122 h 39

EUFNP122 /pouf
/pouf
/pouf

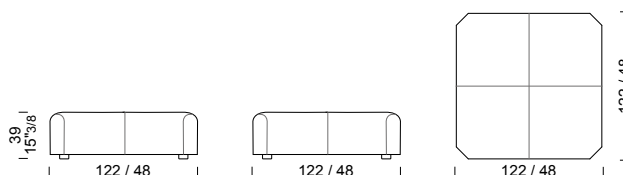

ALL 3,3 mt 5,7 m² 0,63 m³ 45 kg

Composition A

EUFNLS15
EUFNS85 (2)
EUFNANGO
EUFNLD45

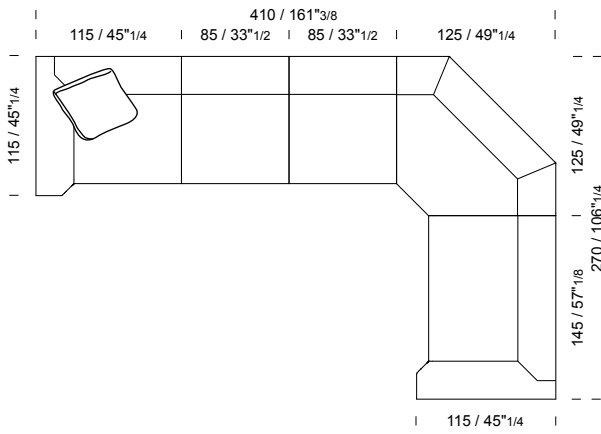

Composition B

EUFNLS25
EUFNS95
EUFNANG6
EUFNLD35

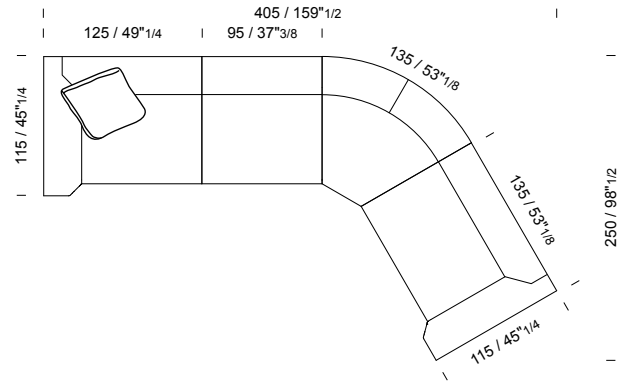

Composition C

EUFNLS25
EUFNS95 (2)
EUB9ANGO (2)
EUFNS115 (2)
EUFNLD25

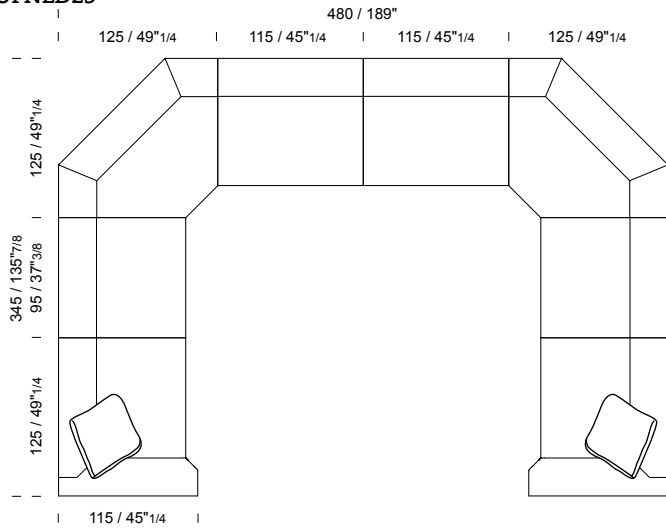

Composition D

EUFNLS35
EUFNS105
EUFNLD35

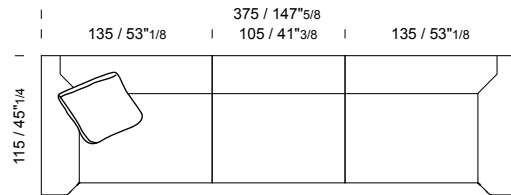

Composition E

EUFNLS45
EUFNANG6 (2)
EUFNS95 (2)
EUFNLD45

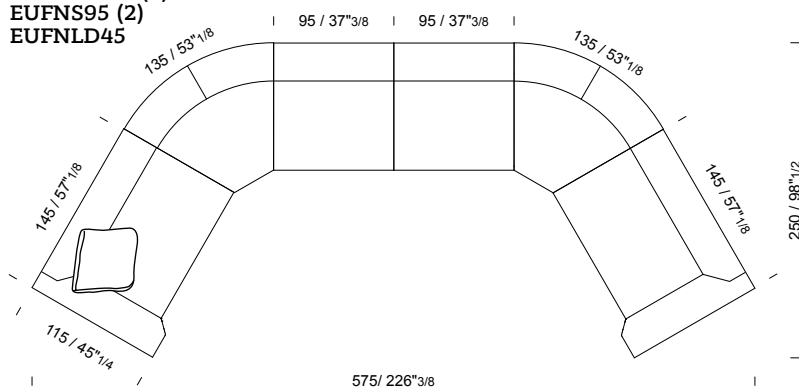

Composition F

EUFNLS35
EUFNS105
EUFNANGO
EUFNS115

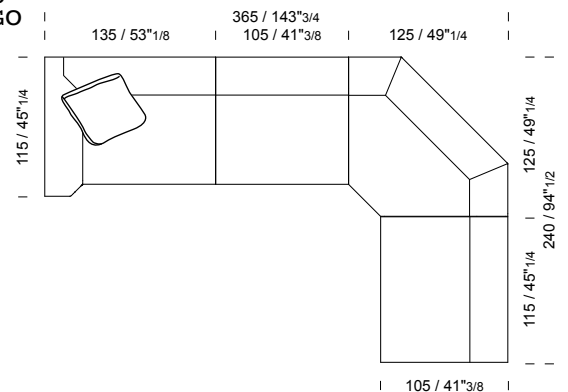

Composition G

EUFNLC2S
EUFNSC18 (2)
EUFNLC2D

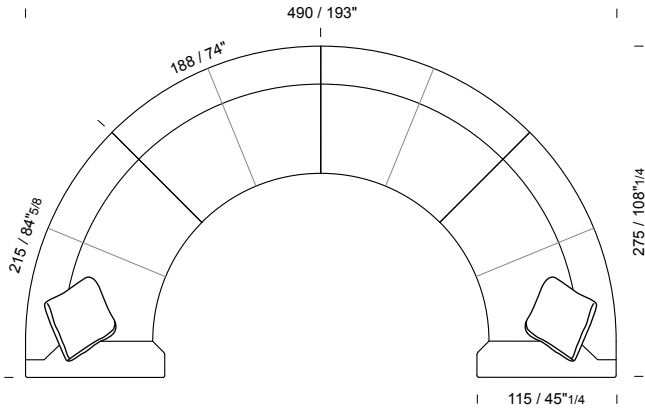

Composition H

EUFNLC2S
EUFNSC18
EUFNLC2D

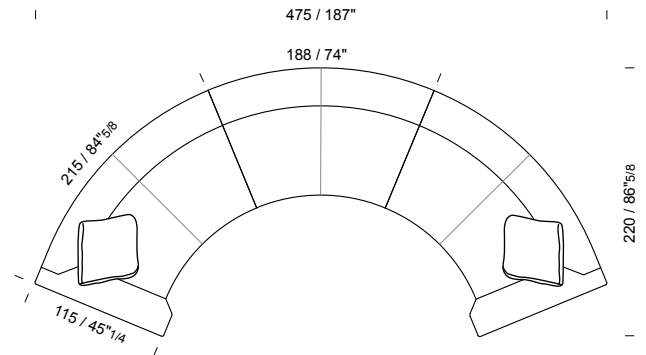

Composition I

EUFNLC2S
EUFNLC2D

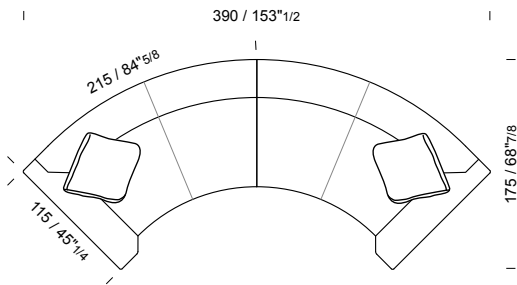

Composition L

EUFNTELS
EUFNTELD

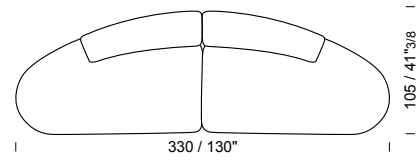

Composition M

EUFNTELS
EUFNSC18
EUFNLC2D

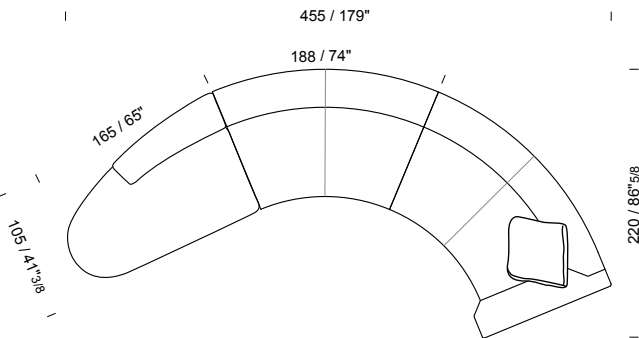

Composition N

EUFNTELS
EUFNSC18
EUFNTELD

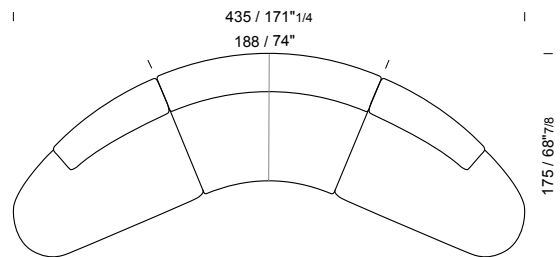

LEGNO
WOOD
BOIS



NATURAL OAK (LA1)



CANALETTO WALNUT (LA2)



LIGHT BROWN OAK (LA1)



BROWN OAK (LA1)



WENGÉ (LA1)



GREY OAK (LA1)



BLACK OAK (LA1)



DARK CASHMERE OAK (LA1)



LACQUERED RAL CODE (LA1)

Tutte le immagini sono inserite a scopo illustrativo, i colori sono puramente indicativi e possono differire dai toni reali. All images are shown for illustrative purposes, the colors are purely indicative and may differ from the real tones. Toutes les images sont présentées à titre d'illustration, les couleurs vues sur l'écran sont purement indicatives et peuvent différer des tons réels.

FILI THREAD FIL



PELLE/LEATHER/CAIR
WHITE

PELLE/LEATHER/CAIR
TUSCANIA 22

PELLE/LEATHER/CAIR
RUSTICO 12

PELLE/LEATHER/CAIR
GHOST 36

Tutte le immagini sono inserite a scopo illustrativo, i colori sono puramente indicativi e possono differire dai toni reali. All images are shown for illustrative purposes, the colors are purely indicative and may differ from the real tones. Toutes les images sont présentées à titre d'illustration, les couleurs vues sur l'écran sont purement indicatives et peuvent différer des tons réels.

COLLEZIONE TRAP TRAP COLLECTION COLLECTION TRAP

Lavorazione ideata dallo studio stile BORZALINO
Special workmanship designed by BORZALINO style studio
Bordure conçue par le studio style BORZALINO

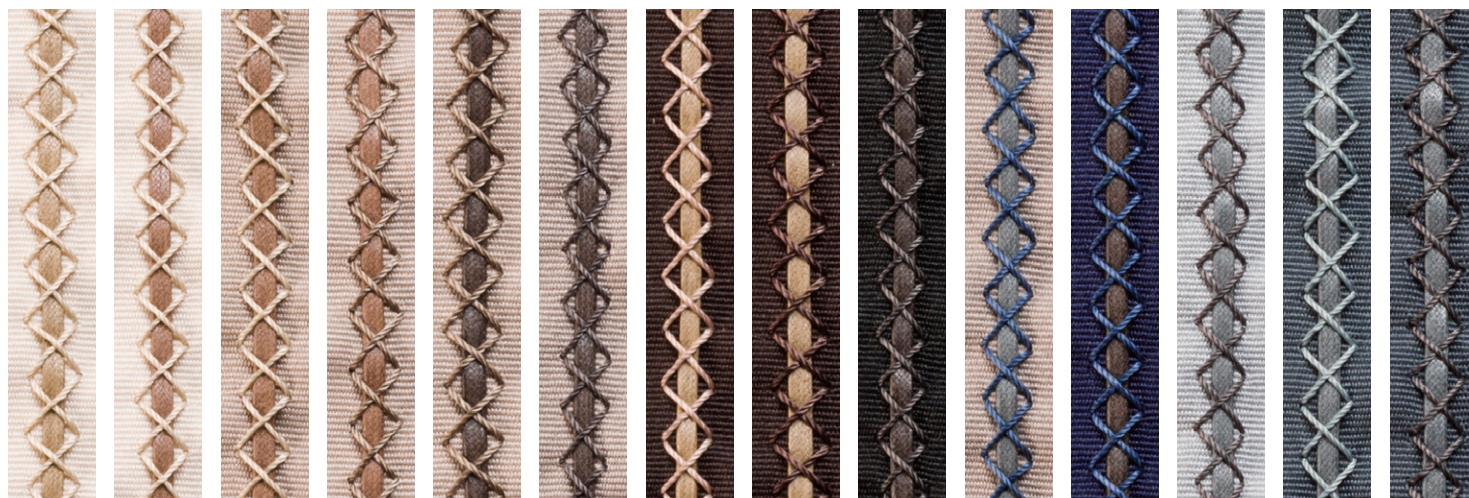

TRAP 11 TRAP 10 TRAP 01 TRAP 08 TRAP 07 TRAP 09 TRAP 04 TRAP 05 TRAP 02 TRAP 03 TRAP 06 TRAP 12 TRAP 14 TRAP 13

GROS-GRAIN

NASTRO PER BORDINI E ALTRI DETTAGLI
RIBBON FOR TRIMMINGS AND OTHER DETAILS
RUBAN POUR PASSEPOIL ET AUTRES DÉTAILS



4508 4527 4503 4555 4519 4522 4536 4514 4518 4554 4548 4525 4559 4531 4528 4512 4509 4510 4513

Tutte le immagini sono inserite a scopo illustrativo, i colori sono puramente indicativi e possono differire dai toni reali. All images are shown for illustrative purposes, the colors are purely indicative and may differ from the real tones. Toutes les images sont présentées à titre d'illustration, les couleurs vues sur l'écran sont purement indicatives et peuvent différer des tons réels.

BORZALINO