

BORZALINO
INTERIORS • 1976 • TUSCANY



AYTON

AYTON

Passato e presente, tradizione e innovazione si incontrano in Ayton, un sistema di divani che genera sensazioni contrastanti: le linee rigorose del supporto si contrappongono alle morbide curve degli imbottiti, le superfici lisce si abbinano a morbidi tessuti, la pelle più pregiata a ricercati filati. La severità del telaio ispirato alle geometrie nordiche degli anni 50, si attenua nella comodità informale della seduta di gusto contemporaneo.

Come un tappeto volante, la struttura si solleva da terra in un piano orizzontale a conchiglia che racchiude un cuore soffice e accogliente. Ayton si compone di varie tipologie di sedute e ripiani combinabili all'infinito per adattarsi con naturalezza agli ambienti domestici e pubblici.

Struttura: in tubolare metallico curvato. **Sospensione seduta:** telaio in multistrato di pioppo sagomato e forato per permettere la fuori uscita dell'aria dal cuscino in piuma. **Supporto schienale:** in tubolare metallico con cinghie elastiche ammortizzanti. **Imbottiture:** Schienale fisso in poliuretano espanso di densità 25Kg/m³ e rivestito con trapuntino in piuma canalizzata per garantire una localizzazione della piuma netta e costante nel tempo. Il trapuntino in piuma conferisce morbidezza e sofficià. Sedute fisse in poliuretano espanso a quote differenziate di densità 35/30/25Kg/m³ rivestito con trapuntino in piuma canalizzata che conferisce sofficià al cuscino. **Dettaglio:** doppia tiratura enfatizzata da ricamo compatto a zig-zag. **Piedini:** in metallo laccato o trattato galvanicamente con appropriati sottopiedi in plastica. Tolleranza +/- 5cm delle dimensioni totali del prodotto.

EN

Past and present, tradition and innovation combine in Ayton, as the strict lines of the support contrast with the soft curves of the upholstery, the smooth surfaces combine with soft fabrics, and the finest leathers with refined yarns. The austerity of the frame, inspired by Nordic geometries of the '50s, fades into the informal comfort of the contemporary seat and backrest. Like a flying carpet, the structure rises from the ground in a horizontal plane as if in a shell that encloses a soft and welcoming heart. Ayton is a fully modular composition of seats and shelves that naturally adapts to every space, from domestic to public.

Structure: in curved metal tube. **Seat springing:** frame in poplar plywood shaped and perforated to allow the exit of air from the feather pillow. **Backrest support:** in metal tube with elastic straps. **Fillings:** fixed backrest in density 25 Kg/m³ polyurethane foam and covered with feather quilt channelled in order to guarantee that the feathers remain neatly and constantly in place over time. The feather quilt gives roundness and softness. Fixed seat cushions in polyurethane foam density 35/30/25Kg/m³ covered with feather quilt channelled that gives softness to the cushion. **Detail:** double stitching emphasized by compact zig zag embroidery. **Feet:** in lacquered metal or galvanized with appropriate plastic glides. Tolerance +/- 5cm of total product dimensions.

FR

Passé et présent, tradition et innovation se rencontrent dans Ayton, un concept des canapés qui suscite des sensations contrastées : les lignes rigoureuses du support contrastent avec les formes souples du coussinage, les surfaces lisses sont assorties à des tissus doux, le cuir le plus raffiné à des fils recherchés. La rigueur du châssis inspiré par les géométries nordiques des années 50, est adoucie par le confort informel d'assise et de dossier dans un style contemporain.

Comme un tapis volant, la structure se détache du sol dans un plan horizontal en forme de coquille qui encadre un cœur doux et accueillant. Ayton est composé de différents types de sièges qui peuvent être combinés à l'infini pour s'adapter naturellement aux environnements domestiques et publics.

Structure : en tube métallique incurvé. **Suspension d'assise :** châssis en multiplis de peuplier profilé et perforé pour permettre la sortie de l'air du coussin en plumes. **Support de dossier :** en tube métallique avec sangles élastiques. **Rembourrage :** dossier fixe en mousse polyuréthane densité 25 Kg/m³ couverts par un couette en duvet à secteurs pour garantir au duvet une localisation nette et constante dans le temps. La couette en duvet donne douceur et souplesse. Coussins d'assise fixes en mousse polyuréthane densité 35/30/25 Kg/m³ couvert par un couette en duvet à secteurs qu'il confère souplesse au coussin. **Détail :** Double étirage soulignée par une broderie zigzag compacte. **Pieds :** en métal laqué ou galvanisé avec des patins en plastique appropriés. Tolérance +/- 5 cm des dimensions totales du produit.

BORZALINO

INTERIORS • 1976 • TUSCANY



sofa 310x90 h 82 - 3 seats 98 / Leather art. TUSCANIA col. 24. Metal feet finish col. Gloss Black.



sectional sofa 347/190x90 h 82 / Element 85 arm LHF seat 78 + Corner 90° + Element 242 arm RHF 3 seats 78
Frame Leather art. SETA col. 32815 / Seat and back cushions fabric art. BUNNIE Z560 col. 02
Arm cushions Fabric art. BUNNIE Z560 col. 02. Metal feet finish col. Vulcan Grey.

DETAILS



ricamo compatto a zig-zag
compact zig zag embroidery
broderie zigzag compacte



piedini in metallo
metal feet
pieds en métal



con tavolo integrato
with built-in-table
avec table intégrée

AYTON



armchair 95x90 h 82

Frame leather art. RUSTICO col. 11. Seat and back fabric art. EGO L1347 col. 02. Metal feet finish col. Vulcan Grey
 Frame leather art. GHOST col. 33. Seat, back and arm cushion art. EDEN col. 002. Metal base finish col. Vulcan Grey

95 h 82 - prof/depth/prof 90

EUAYPOLT /poltrona
/armchair
/fauteuil

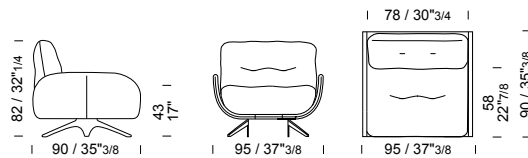

ALL 6 mt 10 m² 0,80 m³ 51 kg

95 h 82 - prof/depth/prof 90

EUAYPOLG /poltrona girevole
/swivel armchair
/fauteuil pivotant

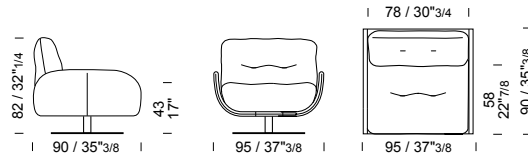

ALL 6 mt 10 m² 0,80 m³ 51 kg

172 h 82 - prof/depth/prof 90

EUAYD02P /divano
/sofa
/canapé

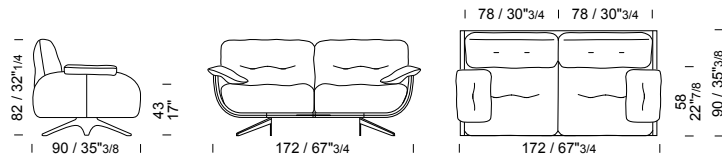

ALL 8 mt 13 m² 1,4 m³ 90 kg

212 h 82 - prof/depth/prof 90

EUAYDINT /divano
/sofa
/canapé

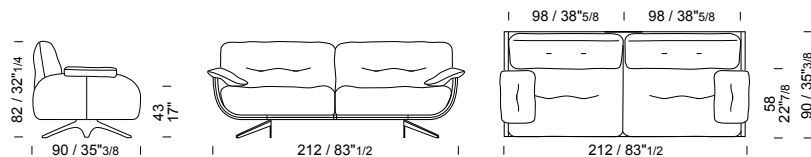

ALL 9 mt 14 m² 1,73 m³ 95 kg

AYTON



sofa 250x90 h 82 - 3 seats 78 / Frame Leather art. GHOST col. 33.
Seat, back and arm cushions fabric art. BONSAI CH2955 col. 085. Metal feet finish col. Vulcan Grey

250 h 82 - prof/depth/prof 90

EUAyD03P /divano
/sofa
/canapé

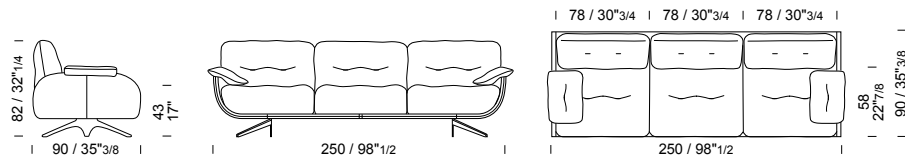

ALL 11,5 mt 18 m² 2,06 m³ 99 kg

310 h 82 - prof/depth/prof 90

EUAyD04P /divano
/sofa
/canapé

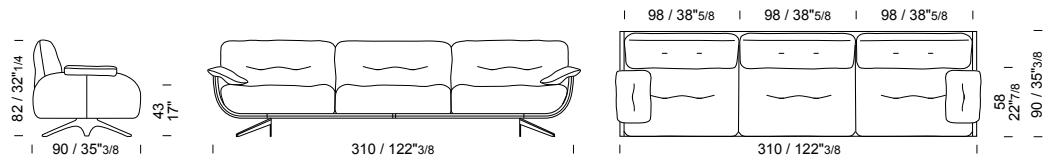

ALL 13 mt 20 m² 2,54 m³ 107 kg

212 h 82 - prof/depth/prof 90

EUAyDT27 /divano con tavolo integrato
/sofa with built-in-table
/canapé avec table intégrée

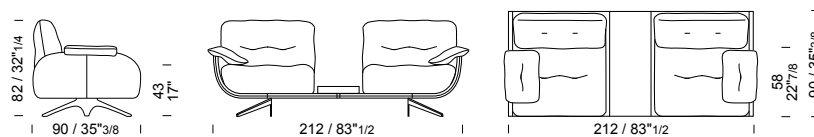

ALL 8 mt 14 m² 1,73 m³ 95 kg

AYTON



sofa with built-in table 250x90 h 82 - 2 seats 98 / Frame leather art. VESUVIO col. 720049.
 Seat and back cushions leather art. SETA col. 681373.
 Arm cushions leather art. SETA col. 681373. Metal feet finish col. Titanio. Table Canaletto walnut wood

250 h 82 - prof/depth/prof 90

EUAYDT29 /divano con tavolo integrato
 /sofa with built-in-table
 /canapé avec table intégrée

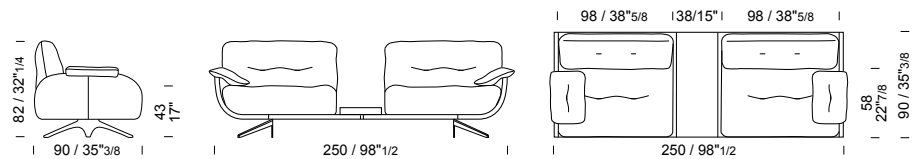

ALL 9 mt 15 m² 2,06 m³ 99 kg

85 h 82 - prof/depth/prof 90

EUAYES17 /laterale SX
 /element LHF
 /batard GVF

EUAYED17 /laterale DX
 /element RHF
 /batard DVF

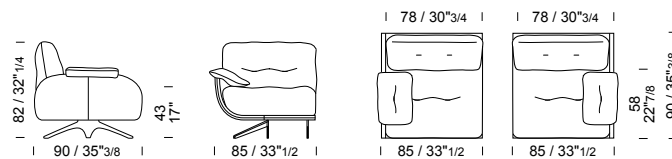

ALL 4,5 mt 9 m² 0,73 m³ 48 kg

105 h 82 - prof/depth/prof 90

EUAYES19 /laterale SX
 /element LHF
 /batard GVF

EUAYED19 /laterale DX
 /element RHF
 /batard DVF

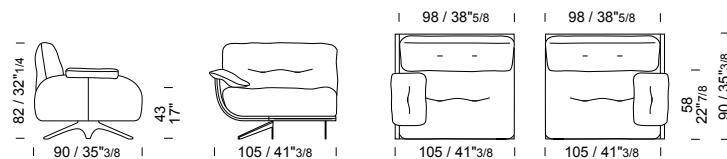

ALL 5 mt 9,5 m² 1,05 m³ 58 kg

AYTON



sectional sofa 316/216x90 h 82 / Element 204 arm LHF 2 seats 98 + Corner + Element 105 arm RHF 1 seat 98
 Frame leather art. VESUVIO col. 370050. Seat and back cushions Velvet art. FILIGRANA col. 05.
 Arm cushions Leather art. VESUVIO col. 370050. Metal feet finish col. Vulcan Grey

164 h 82 - prof/depth/prof 90

EUAYES27 /laterale SX
 /element LHF
 /batard GVF

EUAYED27 /laterale DX
 /element RHF
 /batard DVF

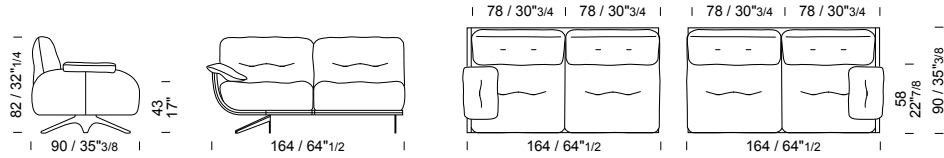

ALL 7 mt 12 m² 1,35 m³ 86 kg

204 h 82 - prof/depth/prof 90

EUAYES29 /laterale SX
 /element LHF
 /batard GVF

EUAYED29 /laterale DX
 /element RHF
 /batard DVF

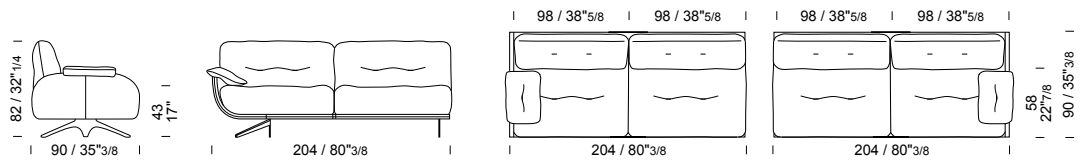

ALL 8 mt 13 m² 1,86 m³ 90,5 kg

242 h 82 - prof/depth/prof 90

EUAYES37 /laterale SX
 /element LHF
 /batard GVF

EUAYED37 /laterale DX
 /element RHF
 /batard DVF

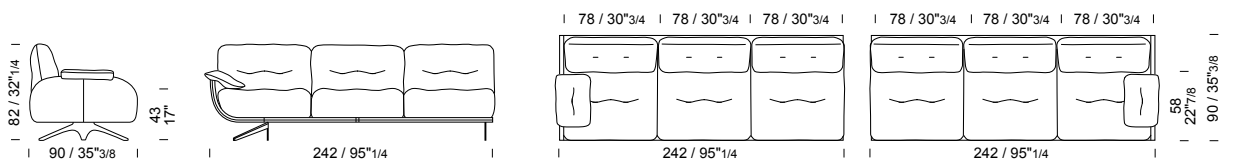

ALL 10 mt 15 m² 1,98 m³ 95 kg

302 h 82 - prof/depth/prof 90

EUAYES39 /laterale SX
/element LHF
/batard GVF

EUAYED39 /laterale DX
/element RHF
/batard DVF

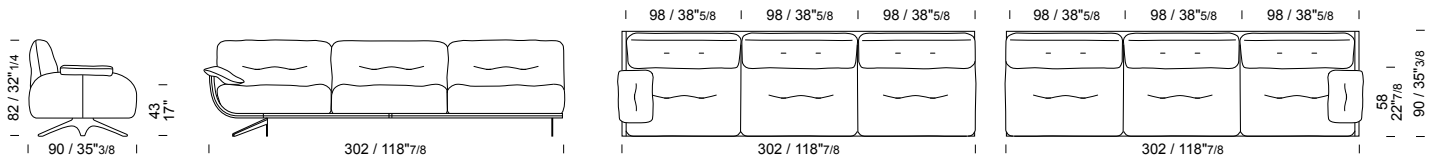

ALL 11 mt 18 m² 2,45 m³ 105 kg

105 h 82 - prof/depth/prof 105

EUAYANGO /angolo 90°
/corner 90°
/angle 90°

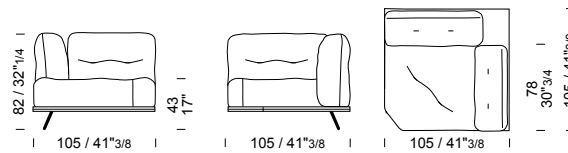

ALL 5,5 mt 8,5 m² 1,03 m³ 61 kg



bench 172x60 h 56 - 2 seats 78 / Frame Leather art. GHOST col. 33.
Seat cushions Leather art. TUSCANIA col. 22. Metal feet finish col. Titanio.

172 h 56 - prof/depth/prof 60

EUAYPA27 /panchetta
/bench
/banc

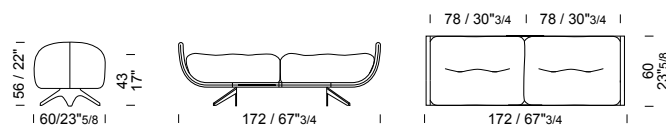

ALL 3,5 mt 6,5 m² 0,63 m³ 43 kg

AYTON

212 h 56 - prof/depth/prof 60

EUAyPA29 /panchetta
/bench
/banc

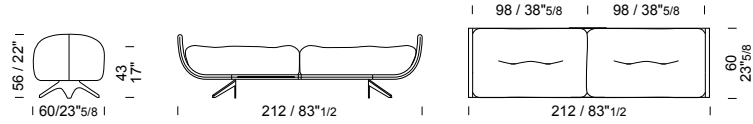

ALL 3,5 mt 6,5 m² 0,75 m³ 50 kg

85 h 43 - prof/depth/prof 60

EUAyPF78 /pouf
/pouf
/pouf



ALL 2 mt 3,5 m² 0,28 m³ 22 kg



pouf 105x60 h 43 / Frame Leather art. GHOST col. 31.
Seat cushion fabric art. KUBOA 9072 col. 02. Metal feet finish col. Titanio.

105 h 43 - prof/depth/prof 60

EUAyPF98 /pouf
/pouf
/pouf

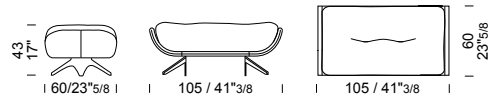

ALL 2 mt 3,5 m² 0,36 m³ 25 kg

45x30

EUAyCB /cuscino decorativo
/pillow
/coussin déco

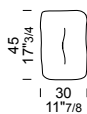

ALL 0,6 mt 0,7 m²

Composition A

EUAYES29
EUAYANGO
EUAYED19

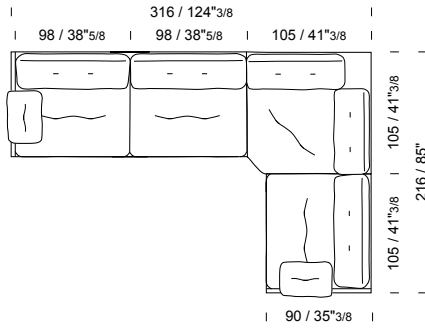

Composition B

EUAYES39
EUAYANGO
EUAYED19

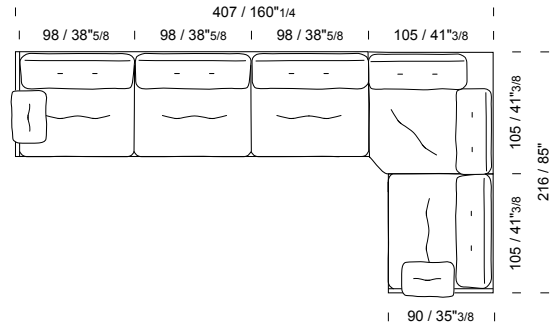

Composition C

EUAYES17
EUAYANGO
EUAYED37

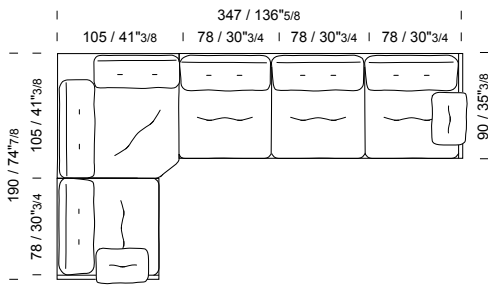

Composition D

EUAYES17
EUAYANGO
EUAYED27

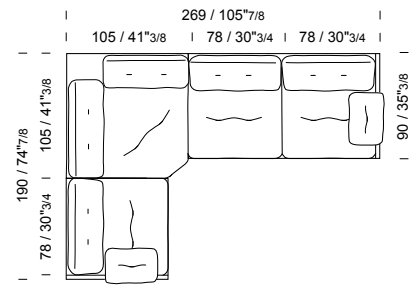

sectional sofa 347/190x90 h 82 / Element 85 arm LHF seat 78 + Corner 90° + Element 242 arm RHF 3 seats 78
Frame Leather art. SETA col. 32815 / Seat and back cushions fabric art. BUNNIE Z560 col. 02
Arm cushions Fabric art. BUNNIE Z560 col. 02. Metal feet finish col. Vulcan Grey.

FILI THREAD FIL



PELLE/LEATHER/CUIR
WHITE

PELLE/LEATHER/CUIR
TUSCANIA 22

PELLE/LEATHER/CUIR
RUSTICO 12

PELLE/LEATHER/CUIR
GHOST 36

Tutte le immagini sono inserite a scopo illustrativo, i colori sono puramente indicativi e possono differire dai toni reali. All images are shown for illustrative purposes, the colors are purely indicative and may differ from the real tones. Toutes les images sont présentées à titre d'illustration, les couleurs vues sur l'écran sont purement indicatives et peuvent différer des tons réels.

METALLO METAL MÉTAL

Fedeli all'idea di una collezione in armonia con il naturale, abbiniamo metalli nelle finiture brunate, satinare, laccate e cromate.

Faithful to the idea of a collection in harmony with the natural, we combine metals in burnished, satin, lacquered and chrome finishes.

Fidèle à l'idée d'une collection en harmonie avec le naturel, nous associons les métaux dans des finitions bruniées, satinées, laquées et chromées.

* A richiesta con supplemento prezzo

* On request with surcharge

* Sur demande avec supplément

VERNICE A POLVERE / POWDER COATING / PEINTURE EN POUVRE



SAND GOLD

YW276I BEIGE

ANODIC BRONZE

YY217E GOLD

Y220NI ROSSO PAMPLONA

SW268JR BRONZE

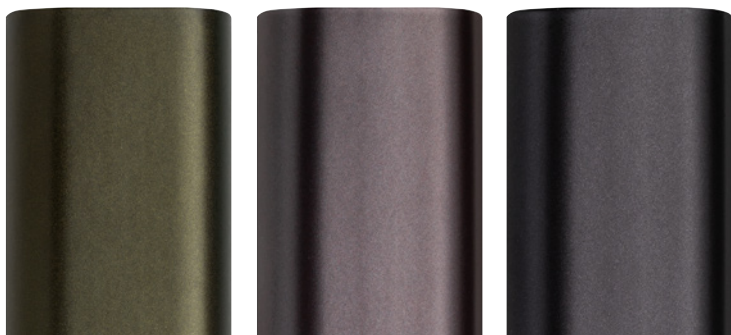

Y220UI VERDE SAMOA

VULCAN GREY

ANODIC BLACK

LACCATO LUCIDO / GLOSS LACQUERED / LAQUÉ BRILLANT

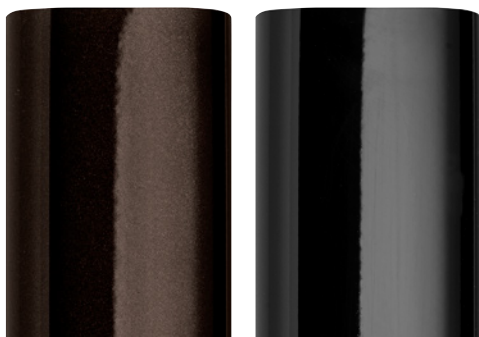

TITANIO *

GLOSS BLACK

LACCATO OPACO / MATT LACQUERED / LAQUÉ MAT



LACQUERED RAL CODE

Tutte le immagini sono inserite a scopo illustrativo, i colori sono puramente indicativi e possono differire dai toni reali. All images are shown for illustrative purposes, the colors are purely indicative and may differ from the real tones. Toutes les images sont présentées à titre d'illustration, les couleurs vues sur l'écran sont purement indicatives et peuvent différer des tons réels.

METALLO METAL MÉTAL

DELABRÉ

Questa finitura asportata a mano, fa in modo che l'artigiano crei ogni volta un pezzo unico. Disponibile in oro unito (V1), bronzo con bordi asportati (V2) oppure bronzo con bordo e superficie asportati (V3).

DELABRÉ

This hand-removed finish ensures that the craftsman creates a unique piece each time. Available in plain gold (V1), bronze with the edge removed (V2) or bronze with the edge and surface removed (V3).

DELABRÉ

Cette finition brossé à la main permet à l'artisan de créer une pièce unique à chaque fois. Disponible en or massif (V1), en bronze avec le bord enlevé (V2) ou en bronze avec le bord et la surface enlevés (V3).

VERNICIATURA DELABRÉ / DELABRÉ FINISHING / FINITION DELABRÉ

LACCATO OPACO ASPORTATO A MANO / HAND-REMOVED MATT LACQUERED / LAQUÉ MAT BROSSÉ À LA MAIN

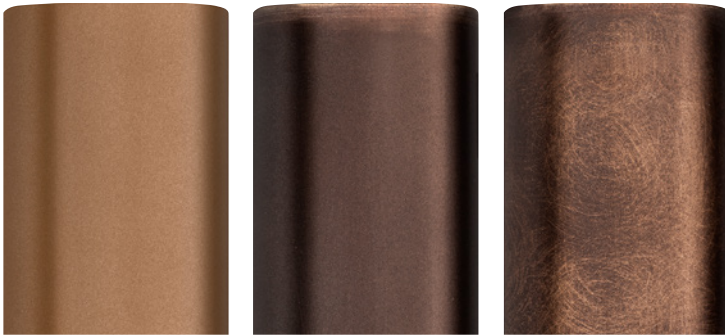

DELABRÉ ORO V1 *

DELABRÉ V2 *

DELABRÉ V3 *

GALVANICA / GALVANIZED / GALVANISATION



CHROME *

SATIN CHROME *

Tutte le immagini sono inserite a scopo illustrativo, i colori sono puramente indicativi e possono differire dai toni reali. All images are shown for illustrative purposes, the colors are purely indicative and may differ from the real tones. Toutes les images sont présentées à titre d'illustration, les couleurs vues sur l'écran sont purement indicatives et peuvent différer des tons réels.

LEGNO WOOD BOIS



NATURAL OAK (LA1)



CANALETTO WALNUT (LA2)



CHALK BROWN OAK (LA1)



LIGHT BROWN OAK (LA1)



BROWN OAK (LA1)



WENGÉ (LA1)



GREY OAK (LA1)



BLACK OAK (LA1)



DARK CASHMERE OAK (LA1)



LACQUERED RAL CODE (LA1)

Tutte le immagini sono inserite a scopo illustrativo, i colori sono puramente indicativi e possono differire dai toni reali. All images are shown for illustrative purposes, the colors are purely indicative and may differ from the real tones. Toutes les images sont présentées à titre d'illustration, les couleurs vues sur l'écran sont purement indicatives et peuvent différer des tons réels.



PIETRA STONE PIERRE

LUCIDO / GLOSS / BRILLANT



CARRARA ARABESCATO (MA1)



CALACATTA VAGLI ORO (MA4)



DAINO REALE (MA1)



TRAVERTINO RIGATO (MA2)



BLUE ISLAND
(QUARTZITE) (MA4)



OCEAN STORM (MA4)



TRAVERTINO GIALLO (MA1)



SEQUOIA BROWN
(QUARTZITE) (MA3)



CAPPUCCINO (MA4)



EMPERADOR DARK (MA1)



PORT LAURENT (MA2)



ROSSO LEVANTO (MA2)



VERDE ALPI (MA2)



SAHARA NOIR (MA2)



NERO MARQUINIA (MA1)



AMAZONITE EXTRA
(QUARTZITE) (MA3)

Tutte le immagini sono inserite a scopo illustrativo, i colori sono puramente indicativi e possono differire dai toni reali. All images are shown for illustrative purposes, the colors are purely indicative and may differ from the real tones. Toutes les images sont présentées à titre d'illustration, les couleurs vues sur l'écran sont purement indicatives et peuvent différer des tons réels.

PIETRA STONE PIERRE

OPACO / MATT / MAT



CALACATTA VAGLI ORO (MA4)



CAPPUCCINO (MA4)



EMPERADOR DARK (MA1)



SAHARA NOIR (MA2)

Tutte le immagini sono inserite a scopo illustrativo, i colori sono puramente indicativi e possono differire dai toni reali. All images are shown for illustrative purposes, the colors are purely indicative and may differ from the real tones. Toutes les images sont présentées à titre d'illustration, les couleurs vues sur l'écran sont purement indicatives et peuvent différer des tons réels.